

EN	INSTALLATION INSTRUCTION COAT HANGER
D	EINBAUANLEITUNG KLEIDERBÜGEL ABNEHMBAR
E	INSTRUCCIONES DE MONTAJE PERCHA
F	NOTICE DE MONTAGE CEINTRE
I	ISTRUZIONI DI MONTAGGIO GRUCCIA APPENDIABILI
P	INSTRUÇÕES DE MONTAGEM CABIDE
NL	INBOUW-INSTRUCTIE KLEDINGHANGER
DK	MONTERINGSVEJLEDNING JAKKEBØJLE
N	MONTERINGSVEILEDNING KLESHENGER
S	MONTERINGSANVISNING KLÄDHÄNGARE
SF	ASENNUSOHJE VAATERIPUSTIN
CZ	NÁVOD K MONTÁŽI RAMÍNKO NA ŠATY
H	BESZERELÉSI UTASÍTÁSA KABÁTAKASZTÓ
PL	INSTRUKCJA MONTAŻU WIESZAK NA PŁASZCZ
GR	ΟΔΗΓΙΕΣ ΤΟΠΟΘΕΤΗΣΗΣ Κρεμάστρα
TR	MONTAJ TALİMATLARI ASKILIK
RUS	ИНСТРУКЦИЯ ПО МОНТАЖУ ВИШАЛКА
RO	INSTRUCȚIUNI DE MONTAJ UMERAȘ

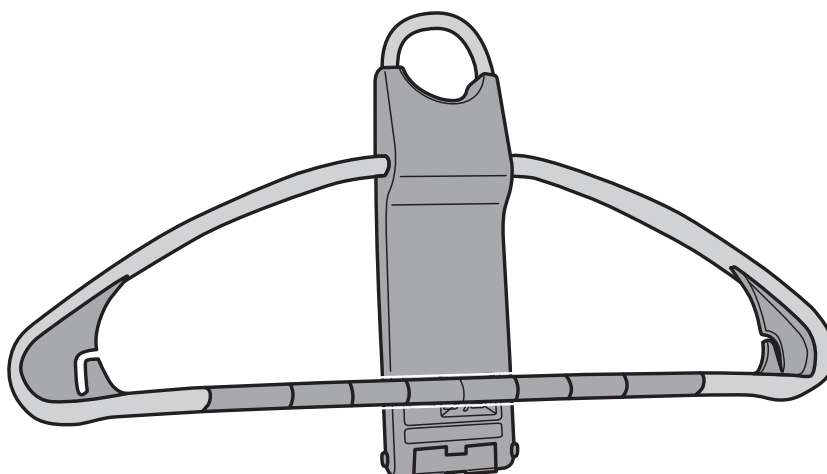

© Copyright Ford-Werke GmbH 2019
Printed Copies are uncontrolled



















Subject to alteration without notice
Technische Änderungen vorbehalten
Reservadas modificaciones técnicas
Sous réserve de modifications techniques
Con riserva di apportare modifiche tecniche
Reservamo-nos o direito a alterações técnicas
Technische wijzigingen voorbehouden
Med forbehold for tekniske ændringer
Tekniske forendringer forbeholdes
Med reservation för tekniska ändringar
Tekniset muutokset pidätetään
Technické zmeny vyhrazeny
A változtatások technika jogát fenntartjuk
Zmiany techniczne zastrzeżone
Επιφύλασσόμεθα για αλλαγές
Производитель оставляет за собой право
вносить в конструкцию технические изменения
Teknik değışiklik hakkı mahfuzdur
Ne rezervăm dreptul la modificări tehnice



A66FLA-A668A86-AA

18/10/2019

1/6

EN		Must not be used in vehicles with active head restraints!
D		Nicht verwendbar für Fahrzeug mit aktiven Kopfstützen!
E		No se debe aplicar para vehículos con reposa-cabezas activos!
F		Ne pas utiliser dans des véhicules avec des appuie-tête actifs!
I		Non utilizzare per i veicoli con poggiatesta attivi!
P		Não utilizar para veículos com apoios de cabeça activo!
NL		Niet te gebruiken voor voertuigen met actieve hoofdsteunen!
DK		Må ikke bruges på køretøjer med aktive nakkestøtter!
N		Må ikke brukes på kjøtøyer med aktive nakkestøtter!
S		Bör inte användas på fordon med aktiva huvudstöd!
SF		Ei sovellu käytettäväksi ajoneuvossa, jossa on aktiiviset pääntuet!
CZ		Není určeno pro vozidla s aktivními opěrkami hlavy!
H		Aktív fej támlával felszerelt gépjárművekben nem használható.
PL		Nie montować w pojeździe z aktywnymi zagłówkami.
GR		Δεν εφαρμόζεται σε αυτοκίνητα με ενεργά στηρίγματα κεφαλής!
TR		Aktif koltuk başlıklı araçlarda kullanılamaz!
RUS		Не подходит для применения в автомобилях с активными подголовниками!
RO		Nu se folosi pentru vehicule cu rezemători activ!

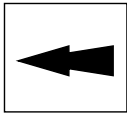

- (EN) Item Arrow
- (D) Pfeil "Komponente"
- (E) Flecha de artículo
- (F) Flèche d'élément
- (I) Freccia indicante oggetto
- (P) Seta indicadora de item
- (NL) Pijl "onderwerp"
- (DK) Pil – Punkt
- (N) Delpil
- (S) Komponentpil
- (SF) Kohteen nuoli
- (CZ) Šipka označující položku
- (H) Tételt jelző nyíl
- (PL) Strzałka wskazująca element
- (GR) Βέλος που υποδεικνύει ένα στεί
- (TR) Parça Oku
- (RUS) Стрелка на пункт
- (RO) Săgeată ce indică articolul

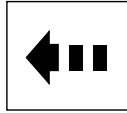

- (EN) Motion Arrow
- (D) Pfeil Bewegung
- (E) Flecha de movimiento
- (F) Flèche de déplacement
- (I) Freccia indicante movimento
- (P) Seta de movimento
- (NL) Pijl "beweging"
- (DK) Retningspil
- (N) Bevegelsespil
- (S) Rörelsepil
- (SF) Liikkeen nuoli
- (CZ) Šipka označující pohyb
- (H) Mozgás irányát jelző nyíl
- (PL) Strzałka wskazująca kierunek ruchu
- (GR) Βέλος που υποδεικνύει κίνηση
- (TR) Hareket oku
- (RUS) Стрелка направления движения
- (RO) Săgeată ce indică mișcarea



- (EN) Caution Symbol
- (D) Symbol "Vorsicht"
- (E) Símbolo de precaución
- (F) Symbole Attention
- (I) Simbolo di attenzione
- (P) Símbolo de Cuidado
- (NL) Symbool "waarschuwing"
- (DK) Symbol – Giv agt
- (N) Varselssymbol
- (S) Varningssymbol
- (SF) Varoitus-symboli
- (CZ) Symbol výstrahy
- (H) Végyszó jelző
- (PL) Ostrożnie
- (GR) Σύμβολο «Προσοχή»
- (TR) Dikkat Sembolü
- (RUS) Знак «Внимание!»
- (RO) Simbol de atenționare



- (EN) Correct
- (D) Richtig
- (E) Correcto
- (F) Correct
- (I) Giusto
- (P) Certo
- (NL) Goed
- (DK) Rigtig
- (N) Riktig
- (S) Rätt
- (SF) Oikein
- (CZ) Správně
- (H) Helyes
- (PL) Prawidłowo
- (GR) Σωστ ό
- (TR) Doğru
- (RUS) Правильно
- (RO) Corect

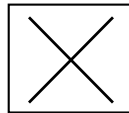

- (EN) Incorrect
- (D) Falsch
- (E) Erróneo
- (F) Incorrect
- (I) Sbagliato
- (P) Errado
- (NL) Fout
- (DK) Forkert
- (N) Feilt
- (S) Fel
- (SF) Väärin
- (CZ) Špatně
- (H) Helyes
- (PL) Nieprawidłowo
- (GR) Λάθος
- (TR) Yanlış
- (RUS) Неправильно
- (RO) Greșit

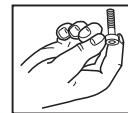

- (EN) Tighten slightly
- (D) Leicht anziehen
- (E) Apretar ligeramente
- (F) Serrer légèrement
- (I) Stringere leggermente
- (P) Apertar ligeiramente
- (NL) iets aanhalen
- (DK) Spænd let
- (N) Skru lett til
- (S) Dra åt lite lätt
- (SF) Kiristä hiukan
- (CZ) Lehce utáhnout
- (H) Kissé húzza meg
- (PL) Lekko dokręcić
- (GR) Σφίγγετε ελαφρώς
- (TR) Hafifçe sıkınız
- (RUS) Слегка затянуть
- (RO) A se strânge ușor

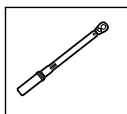

- (EN) Tools Required
- (D) Benötigte Werkzeuge
- (E) Herramientas requeridas
- (F) Outils requis
- (I) Strumenti necessari
- (P) Ferramentas necessárias
- (NL) Benodigd gereedschap
- (DK) Nødvendige værktøjer
- (N) Nødvendig verktøy
- (S) Nödvändiga verktyg
- (SF) Tarvittavat työkalut
- (CZ) Potřebné nástroje
- (H) Szükséges szerszámok
- (PL) Potrzebne narzędzia
- (GR) Εργαλεία που απαιτούνται
- (TR) Gerekl Araçlar
- (RUS) Необходимые инструменты
- (RO) Uneelte necesare

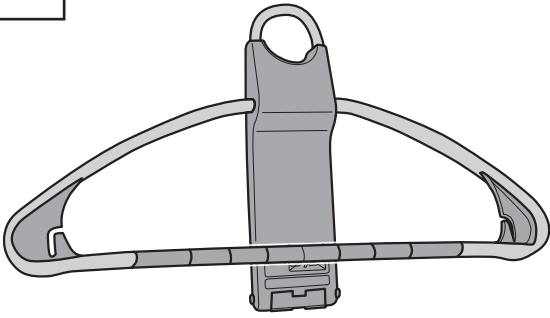

A

1x

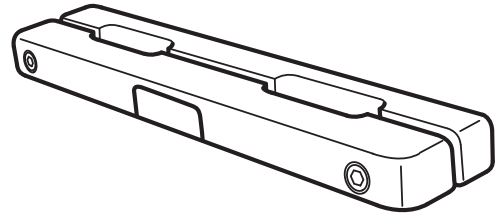
B

1x

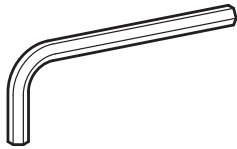
C

1x

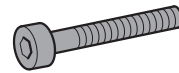
D

3x

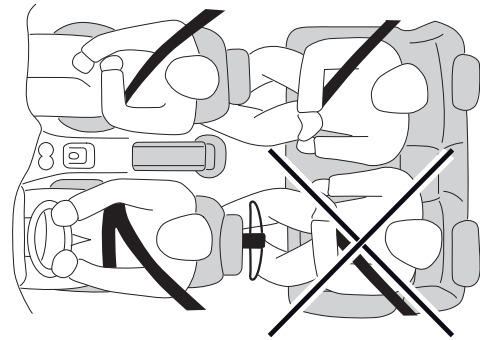
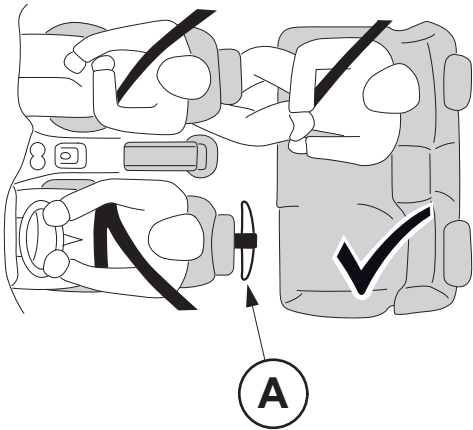
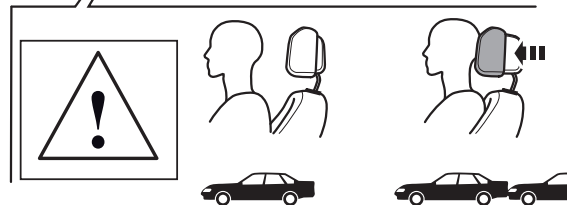
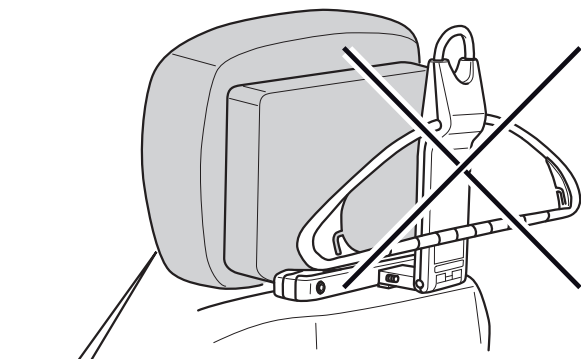
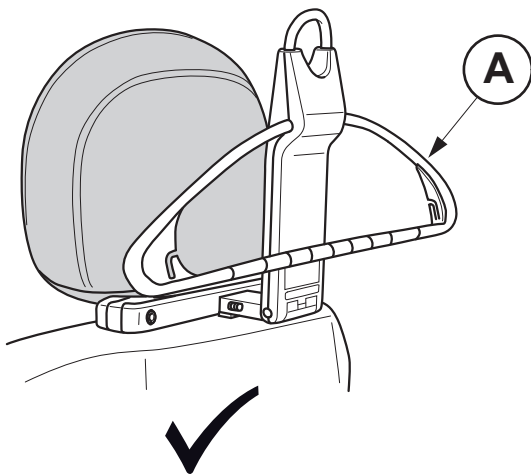
**1****2**

