

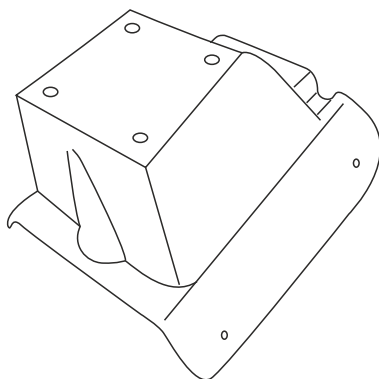

## MINI II. 2007-2014

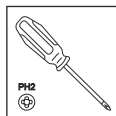

A

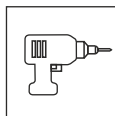
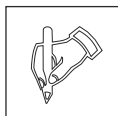
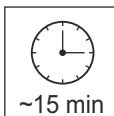
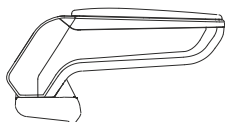

armster **S**

B

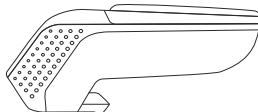

armster **2**

C

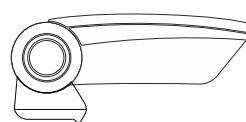

armster **3**

V01644



4x



St 4,8x16

1x



00190

