

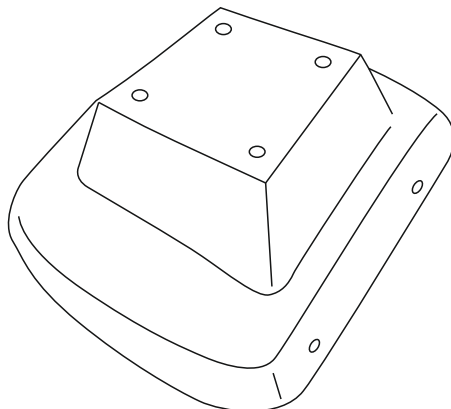

## NISSAN MICRA 2017-2023

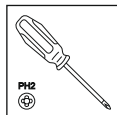
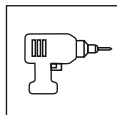
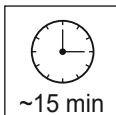

A

B

C

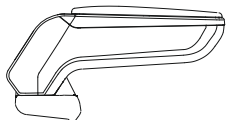

armster **S**

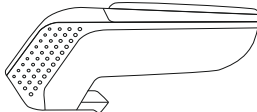

armster **2**

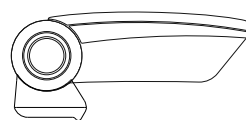

armster **3**

V01628

4x

1x



ABS



St 4,8x16



00456

