

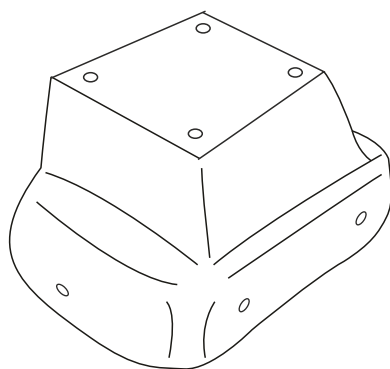

SUZUKI SWIFT 2005-2011

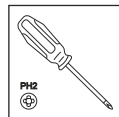

A

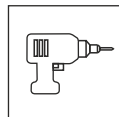
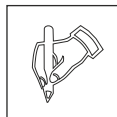
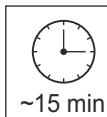
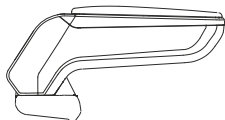

armster **S**

B

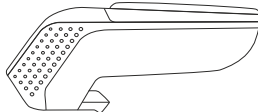

armster **2**

C

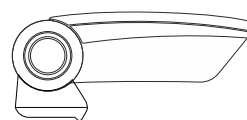

armster **3**

V01664



5x



St 4,8x16

1x



00158

rati | armster adapter

