

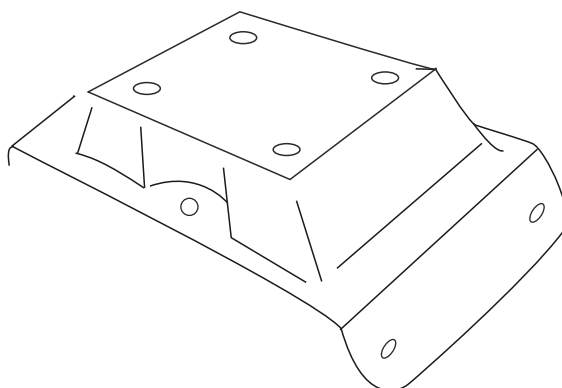

OPEL ZAFIRA B 2007-2014

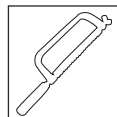
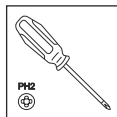
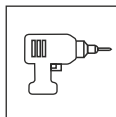
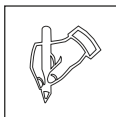
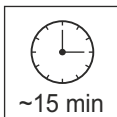

A

B

C

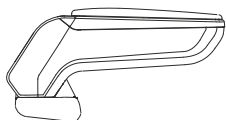

armster **S**

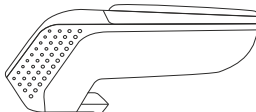

armster **2**

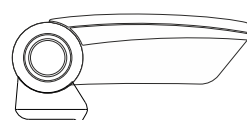

armster **3**

V01635

4x

1x

1x



St 4,8x9,5



St 4,8x9,5



00180

rati | armster adapter

