

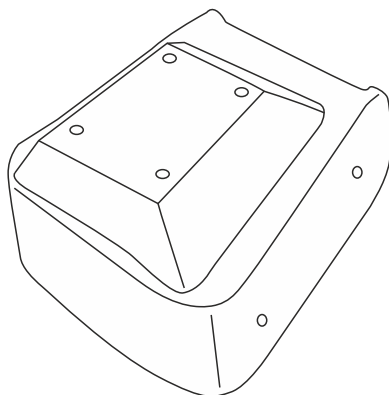

KIA RIO 2017- / STONIC 2017-

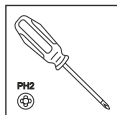
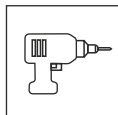
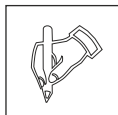
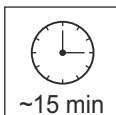

A

B

C

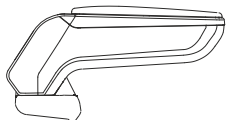

armster **S**

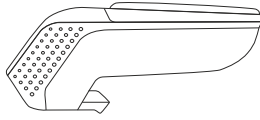

armster **2**

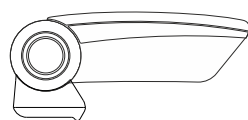

armster **3**

V01621

4x

1x



St 4,8x9,5



00451

rati | armster adapter

