

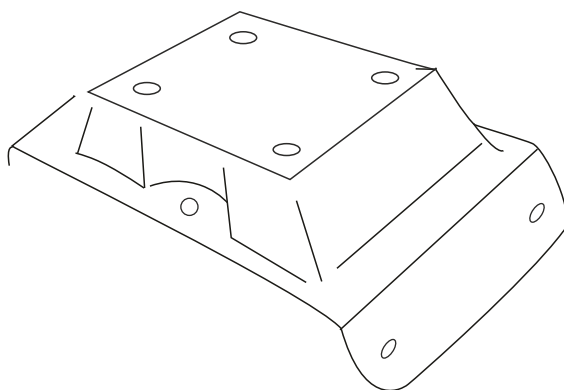

## OPEL ZAFIRA B 2007-2014

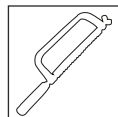
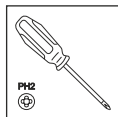
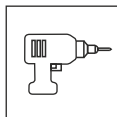
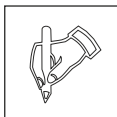
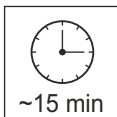

A

B

C

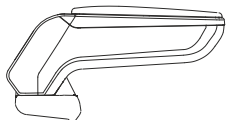

armster **S**

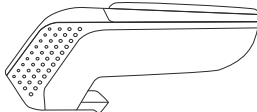

armster **2**

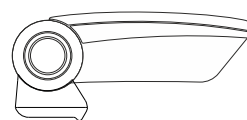

armster **3**

V01635



4x



St 4,8x9,5

1x



St 4,8x9,5

1x



00180

# rati | armster adapter

