

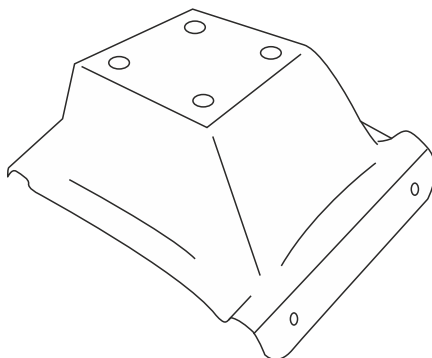

## SKODA OCTAVIA II 2004-2013 YETI 2009-2017

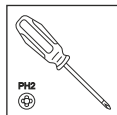

**A**

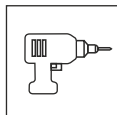
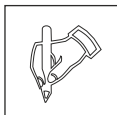
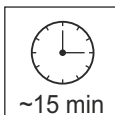
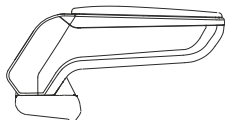

armster **S**

**B**

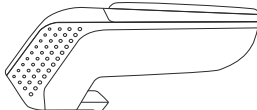

armster **2**

**C**

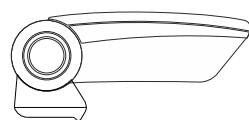

armster **3**

V01607



4x



St 4,8x16

1x

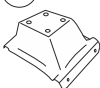

00163

