

rati | armster adapter

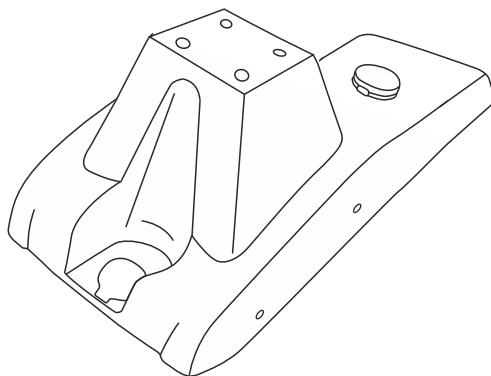

FORD CONNECT 2014- +USB +AUX

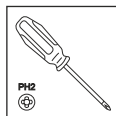
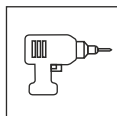
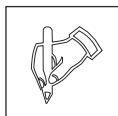
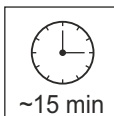

A

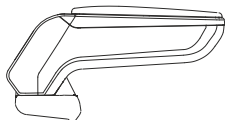

armster **S**

B

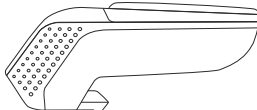

armster **2**

C

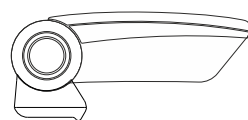

armster **3**

V01595



4x



St 4,8x16

1x



00350

1x



1x



1x



