

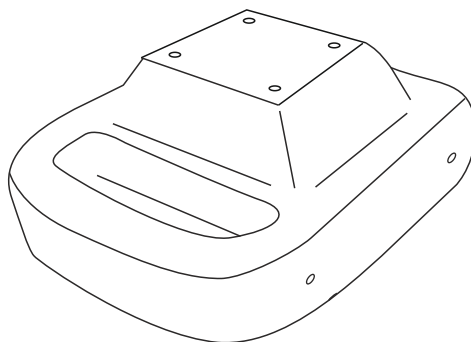

OPEL ASTRA J (RHD) 2009-2015

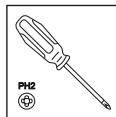

A

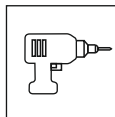
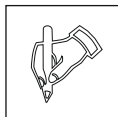
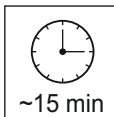
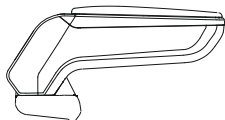

armster **S**

B

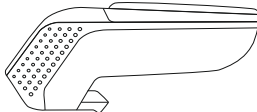

armster **2**

C

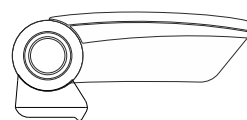

armster **OE1**

V01693



4x



St 4,8x16

1x



00401

